





F-72
Single Channel

F-73
Dual Channel

Features:

- Up to 5 calibration points for pH and Ion
- 5 pH buffer groups – USA, NIST, NIST2, China, and Custom
- 0.01 and 0.001 pH resolutions
- pH calibration interval setting – 1 to 999 days
- 1-point ORP calibration
- Ion calibration curve and standard addition methods
- Temperature sensor calibration function
- Single channel for F-72 and dual channel display for F-73

Ordering Information:

Meter Kit*	 <p>F-72A-S (3999960011)</p> <ul style="list-style-type: none"> • F-72 meter • electrode stand • protection cover • power adaptor with 6 plugs • data acquisition software in USB • 9615S-10D - refillable, glass-body pH electrode with integrated temperature sensor, 1m cable, BNC & phono jack • 502-S - pH 4.01, 7.00, 10.01, 3.33M KCl solutions (250ml each) 	 <p>F-73A-S (3999960012)</p> <ul style="list-style-type: none"> • F-73 meter • electrode stand • protection cover • power adaptor with 6 plugs • data acquisition software in USB • 9615S-10D - refillable, glass-body pH electrode with integrated temperature sensor, 1m cable, BNC & phono jack • 502-S - pH 4.01, 7.00, 10.01, 3.33M KCl solutions (250ml each)
Meter Kit with 21 CFR Part 11 Software	F-72A-S-CFR (3999960210)	F-73A-S-CFR (3999960212)
Meter with Electrode Stand	F-72G (3000347100) <ul style="list-style-type: none"> • F-72 meter • electrode stand • protection cover • power adaptor with 6 plugs • data acquisition software in USB 	F-73G (3000347200) <ul style="list-style-type: none"> • F-73 meter • electrode stand • protection cover • power adaptor with 6 plugs • data acquisition software in USB
pH Electrode	9615S-10D (3200585428) <ul style="list-style-type: none"> • refillable, glass-body pH electrode with integrated temperature sensor, 1m cable, BNC & phono jack 	9615S-10D (3200585428) <ul style="list-style-type: none"> • refillable, glass-body pH electrode with integrated temperature sensor, 1m cable, BNC & phono jack
USA pH Buffer Set	502-S (3999960016) <ul style="list-style-type: none"> • pH 4.01, 7.00, 10.01, 3.33M KCl solutions (250ml each) 	502-S (3999960016) <ul style="list-style-type: none"> • pH 4.01, 7.00, 10.01, 3.33M KCl solutions (250ml each)
NIST pH Buffer Set	501-S (3999960015) <ul style="list-style-type: none"> • pH 4.01, 6.86, 9.18, 3.33M KCl solutions (250ml each) 	501-S (3999960015) <ul style="list-style-type: none"> • pH 4.01, 6.86, 9.18, 3.33M KCl solutions (250ml each)







*Kit with 501-S is available upon request. Add 'N' suffix to the order code when ordering.

Model	F-72 pH/ORP/Ion/Temp (°C)	F-73 Dual Channel pH/ORP/Ion/Temp (°C)
pH Range	-2.000 to 20.000 pH	-2.000 to 20.000 pH
Resolution	0.01 / 0.001 pH	0.01 / 0.001 pH
Accuracy	± 0.001 pH	± 0.001 pH
Calibration Points	Up to 5	Up to 5
Buffer Options	USA, NIST, NIST2, China, Custom	USA, NIST, NIST2, China, Custom
ORP Range	± 1999.9 mV	± 1999.9 mV
Resolution	0.1 mV	0.1 mV
Accuracy	±0.2 mV	±0.2 mV
Ion Range	0.000 µg/L to 9999 g/L (mol/L)	0.000 µg/L to 9999 g/L (mol/L)
Resolution	4 significant digits	4 significant digits
Accuracy	± 0.3% of full scale	± 0.3% of full scale
Calibration Points	Up to 5	Up to 5
Temperature Range	-30.0 °C to 130.0 °C	-30.0 °C to 130.0 °C
Resolution	0.1 °C	0.1 °C
Accuracy	±0.4°C	±0.4°C
Calibration Option	Yes	Yes
Navigation Function	Yes	Yes
Memory	2000	2000
Auto Data-Logging	Yes	Yes
Data Search	Yes	Yes
Custom Printing	Yes	Yes
Real Time Clock	Yes	Yes
Date / Time Stamp	Yes	Yes
Sample ID Input	Yes	Yes
Operator ID Input	Yes	Yes
Password Setting	Yes	Yes
Auto Stable / Auto Hold	Yes	Yes
Offset / Slope Display	Yes (independent acid and alkaline slopes depending on calibration)	Yes (independent acid and alkaline slopes depending on calibration)
Calibration Alarm Limit	Yes	Yes
Electrode Status	On screen display	On screen display
Diagnostic Messages	Yes	Yes
Display	Touch screen color graphic LCD	Touch screen color graphic LCD
Languages	English / Japanese / Chinese / Korean / Vietnamese	English / Japanese / Chinese / Korean / Vietnamese
Inputs	BNC, phono, DC socket	Dual BNC, dual phono, DC socket
Outputs	USB, RS232C, analog output	USB, RS232C, analog output
Power Requirements	AC adaptor 100 ~ 240V, 50/60 Hz	AC adaptor 100 ~ 240V, 50/60 Hz
Electrode Stand	Stand alone	Stand alone
Weight	700g	700g
Dimensions	170 (W) x 174 (D) x 73 (H) mm	170 (W) x 174 (D) x 73 (H) mm



Combination ISE

Ion-selective electrodes are responsive to concentration of particular ions in the test liquid and are variable-potential electrodes. They are used in conjunction with reference electrodes to measure the concentration of particular ions. HORIBA's years of experience and know-how in this field are behind the wide range of ion electrodes we offer.

When measurements are made using an ion meter, calibrating it with various standard solutions will give direct readings of the ion concentration. Note that since volume-detection level changes with temperature, measurements must be taken at a fixed temperature.

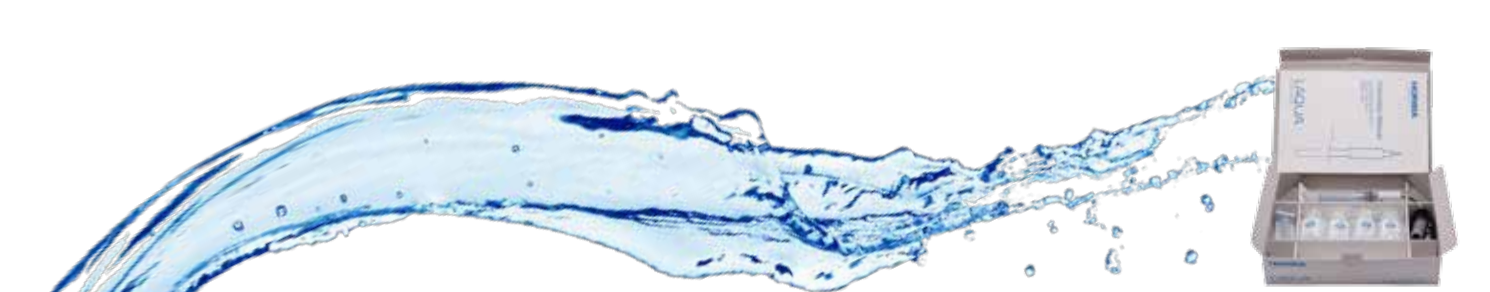
Model	Accessories Included	Temp. Range (°C)	Measurement Range	pH Range
 <p>Ammonia ion (NH₃) electrode 5002S-10C 3200698386 Overall length: 161 mm Diameter of probe: 15 mm Connector: BNC</p>	<ul style="list-style-type: none"> • membrane cap, 3pcs • 1000mg/L ammonium ion standard solution, 50ml • 100mg/L ammonium ion standard solution, 50ml • ammonia electrode filling solution, 50ml • syringe • dropper • protective pipe • manual 	0 - 50	0.01 - 18,000 mg/L NH ₄ ⁺ (5 x 10 ⁻⁷ to 1 mol/L NH ₄ ⁺)	pH 12 or more
 <p>Calcium ion (Ca²⁺) electrode 6583S-10C 3200697410 Overall length: 150 mm Diameter of probe: 16 mm Connector: BNC</p>	<ul style="list-style-type: none"> • calcium electrode tip, 2pcs • 1000mg/L calcium ion standard solution, 50ml • 100mg/L calcium ion standard solution, 50ml • calcium electrode filling solution, 50ml • calcium ionic strength adjustor, 50ml • syringe • dropper • protective pipe • manual 	0 - 50	0.4 - 40,080 mg/L Ca ²⁺ (10 ⁻⁵ to 1 mol/L Ca ²⁺)	4.0 mg/L (10 ⁻⁴ mol/L) Ca ²⁺ , pH 5 to 11
 <p>Chloride ion (Cl⁻) electrode 6560S-10C 3200697407 Overall length: 150 mm Diameter of probe: 16 mm Connector: BNC</p>	<ul style="list-style-type: none"> • chloride electrode tip • 1000mg/L chloride ion standard solution, 50ml • 100mg/L chloride ion standard solution, 50ml • chloride electrode filling solution, 50ml • chloride ionic strength adjustor, 50ml • syringe • dropper • protective pipe • water-resistant abrasive sheet • manual 	0 - 50	0.35 - 35,000 mg/L Cl ⁻ (10 ⁻⁵ to 1 mol/L Cl ⁻)	350 mg/L (10 ⁻² mol/L) Cl ⁻ , pH 3 to 11
 <p>Fluoride ion (F⁻) electrode 6561S-10C 3200693774 Overall length: 150 mm Diameter of probe: 16 mm Connector: BNC</p>	<ul style="list-style-type: none"> • fluoride electrode tip • 1000mg/L fluoride ion standard solution, 50ml • 100mg/L fluoride ion standard solution, 50ml • fluoride electrode filling solution, 50ml • fluoride ionic strength adjustor, 50ml • syringe • dropper • protective pipe • manual 	0 - 50	0.02 - 19,000 mg/L F ⁻ (10 ⁻⁶ to 1 mol/L F ⁻)	0.1 to 1,000 mg/L F ⁻ , pH 5 to 8
 <p>Nitrate ion (NO₃⁻) electrode 6581S-10C 3200697408 Overall length: 150 mm Diameter of probe: 16 mm Connector: BNC</p>	<ul style="list-style-type: none"> • nitrate electrode tip, 2pcs • 1000mg/L nitrate ion standard solution, 50ml • 100mg/L nitrate ion standard solution, 50ml • nitrate electrode filling solution, 50ml • nitrate ionic strength adjustor, 50ml • syringe • dropper • protective pipe • manual 	0 - 50	0.62 - 62,000 mg/L NO ₃ ⁻ (10 ⁻⁵ to 1 mol/L NO ₃ ⁻)	62 mg/L (10 ⁻³ mol/L) NO ₃ ⁻ , pH 3 to 7
 <p>Potassium ion (K⁺) electrode 6582S-10C 3200697409 Overall length: 150 mm Diameter of probe: 16 mm Connector: BNC</p>	<ul style="list-style-type: none"> • potassium electrode tip, 2pcs • 1000mg/L potassium ion standard solution, 50ml • 100mg/L potassium ion standard solution, 50ml • potassium electrode filling solution, 50ml • potassium ionic strength adjustor, 50ml • syringe • dropper • protective pipe • manual 	0 - 50	0.39 - 39,000 mg/L K ⁺ (10 ⁻⁵ to 1 mol/L K ⁺)	3.9 mg/L (10 ⁻⁴ mol/L) K ⁺ , pH 5 to 11



Selection Coefficient	Replacement Tip	Electrode Filling Solution	100mg/L Standard Solution	1000mg/L Standard Solution	Ionic Strength Adjustor	Applications
—	 <p>NH₃ electrode membrane caps 3200705774</p>	500-NH3-IFS 3200697173	500-NH4-SL 3200697172	500-NH4-SH 3200697171	500-NH3-ISA 3200697174 	Agriculture, Soil, Power Station Water, Fish Tanks, Sea Water, Waste Water, Plating Baths, Air / Stack Gases and Biological Cultures or Samples
$Fe^{3+} = 0.1, Fe^{2+}, Zn^{2+} = 1, Sr^{2+} = 50$ $Ni^{2+}, Cu^{2+} = 70, Co^{2+} = 350$ $Mn^{2+} = 500, Mg^{2+} = 1,000$ $Na^+, K^+, Ba^{2+}, NH_4^+ = \text{over } 1,000$	 <p>7683S 3200697414</p>	500-CA-IFS 3200697177	500-CA-SL 3200697176	500-CA-SH 3200697175	500-CA-ISA 3200697178	Agriculture / Plant Tissue, Soil, Water Softening Systems, Boiler Feed Water, Drinking / Mineral Water, Biological Cultures, Dental / Clinical Analysis and Dairy / Food / Beverages Applications
$S_2O_3^{2-}, S^{2-}, I^-, Ag^+, Hg^{2+} = \text{Not acceptable}$ $SCN^- = 0.3, MnO_4^- = 0.1$ $Br^- = 0.03$ $NO_3^-, F^-, HCO_3^-, SO_4^{2-}, PO_4^{2-} = 1,000$	 <p>7660S 3200697411</p>	500-CL-IFS 3200697169	500-CL-SL 3200697168	500-CL-SH 3200697167	500-CL-ISA 3200697170	Agriculture, River / Tap Water, Plant Tissue, Soils, Boiler Feed Water, Clinical Analysis, Sweat, Urine, Cement, Plating Baths and Dairy / Food / Beverages Samples
Possible interference when multiply-charged ion (ex. Al^{3+}, Fe^{3+}) coexisted and foamed the complex.	 <p>7661S 3200693606</p>	500-F-IFS 3200697165	500-F-SL 3200697164	500-F-SH 3200697163	500-F-TISAB 3200697166	Dental / Toothpaste / Mouth Wash, Drinking / Seawater, Wastewater, Air / Stack Gases, Acids, Soils, Food, Biological Fluids, Plant Tissue, Coal, Carbonated Beverages and Bone
$ClO_4^-, I^- = \text{Not acceptable}, Br^- = 2$ $NO_2^- = 3, Cl^- = 300$ $HCO_3^-, H_2PO_4^-, SO_4^{2-} = \text{over } 1000$	 <p>7681S 3200697412</p>	500-NO3-IFS 3200697181	500-NO3-SL 3200697180	500-NO3-SH 3200697179	500-NO3-ISA 3200697182	Agriculture / Plant Tissue / Fertilizers, Surface / Seawater / Drinking Water, Sewage Effluent, Soils, Meats, Vegetables, Foods / Beverages
$Rb^+ = 0.4, Cs^+ = 3, NH_4^+ = 70$ $Li^+, Na^+, Mg^{2+}, Ca^{2+}, Sr^{2+}, Ba^{2+} = \text{over } 1,000$	 <p>7682S 3200697413</p>	500-K-IFS 3200697185	500-K-SL 3200697184	500-K-SH 3200697183	500-K-ISA 3200697186	Agriculture / Plant Tissue, Soils, Wastewater, River / Tap Water, Clinical Analysis, Saliva, Serum, Fertilizers, Soils and Wines, Dairy / Foods / Beverages

Note: Detailed information on standard solutions, ISAs, and filling solutions can be found on page 21



Calcium Ion Electrode Solutions



Chloride Ion Electrode Solutions



Fluoride Ion Electrode Solutions



Potassium Ion Electrode Solutions



Ammonia Ion Electrode Solutions



Nitrate Ion Electrode Solutions

Ion Standard Solutions











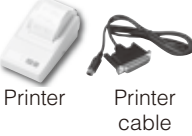



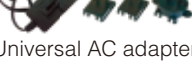

Code	Part No.	Description	Volume
500-NH4-SH	3200697171	1000 mg/L Ammonium Ion Standard Solution	500ml
500-NH4-SL	3200697172	100 mg/L Ammonium Ion Standard Solution	500ml
500-CA-SH	3200697175	1000 mg/L Calcium Ion Standard Solution	500ml
500-CA-SL	3200697176	100 mg/L Calcium Ion Standard Solution	500ml
500-CL-SH	3200697167	1000 mg/L Chloride Ion Standard Solution	500ml
500-CL-SL	3200697168	100 mg/L Chloride Ion Standard Solution	500ml
500-F-SH	3200697163	1000 mg/L Fluoride Ion Standard Solution	500ml
500-F-SL	3200697164	100 mg/L Fluoride Ion Standard Solution	500ml
500-NO3-SH	3200697179	1000 mg/L Nitrate Ion Standard Solution	500ml
500-NO3-SL	3200697180	100 mg/L Nitrate Ion Standard Solution	500ml
500-K-SH	3200697183	1000 mg/L Potassium Ion Standard Solution	500ml
500-K-SL	3200697184	100 mg/L Potassium Ion Standard Solution	500ml

Ionic Strength Adjustors

Code	Part No.	Description	Volume
500-NH3-ISA	3200697174	Ammonia Ionic Strength Adjustor 	500ml
500-CA-ISA	3200697178	Calcium Ionic Strength Adjustor	500ml
500-CL-ISA	3200697170	Chloride Ionic Strength Adjustor	500ml
500-F-TISAB	3200697166	Fluoride Ionic Strength Adjustor	500ml
500-NO3-ISA	3200697182	Nitrate Ionic Strength Adjustor	500ml
500-K-ISA	3200697186	Potassium Ionic Strength Adjustor	500ml

Ion Selective Electrode Filling Solutions

Code	Part No.	Description	Volume
500-NH3-IFS	3200697173	Ammonia Electrode Filling Solution	500ml
500-CA-IFS	3200697177	Calcium Electrode Filling solution	500ml
500-CL-IFS	3200697169	Chloride Electrode Filling Solution	500ml
500-F-IFS	3200697165	Fluoride Electrode Filling Solution	500ml
500-NO3-IFS	3200697181	Nitrate Electrode Filling Solution	500ml
500-K-IFS	3200697185	Potassium Electrode Filling Solution	500ml

Accessories		
Code	Part No.	Description
 LAQUA-SW-21CFR11	3200707161	21 CFR Part 11 Software includes CD with PIN code, USB cable, and manual
	3014030147 (230v) 3014030146 (120v)	Printer (for GLP/GMP compliance) Cable sold separately, Plain paper
	3014030148	Printer cable (1.5 m)
	3014030149	Printer paper (20 rolls)
	3014030150	Ink ribbon (5 pcs/set)
	3200647413	Multi-Voltage (100-240V) with 6 plugs, (US, UK, EU, ANZ, Korea and China) 1.8 m cable
	3014028368	Digital simulator X-51 (pH, mV, Ion, DO, temperature simulator)
	3014028370	Digital simulator X-52 (Conductivity, temperature simulator)
	3200382462	LCD protection sheet (2 pcs/pack)
	3200382441	Protection cover (Protects the meter for F-70, DS-70, 1000 series)
	3200373941	USB cable (to connect meter and PC.)
	3014030152	Analog cable (Analog (alarm) output cable)
	3014030151	Serial cable (to connect meter and PC (Serial, 9 pins))
FA-70S	3200382557	Adjustable, free-standing electrode stand (Height: 384 mm) <i>image on the right</i>
FA-70L	3200382560	Long, free-standing electrode stand (Height: 450-650mm) <i>image on the right</i>
	3200373991	Arm for electrode stand FA-70A, FA-70S, & FA-70L
	3200373961	Electrode holders, 2pcs (for mounting electrode with round cap on electrode stand arm)
	3200382477	Electrode protection caps, 3pcs (for 9615S-10D, 9618S-10D, 9681S-10D pH electrode)
	3200043508	Electrode protection caps, 5pcs (for 9621-10D, 9625-10D, 9630-10D, 9631-10D, 9632-10D, 6367-10D, 6377-10D, 6252-10D, 6261-10C, 1066A-10C, 1076-10C, 2060-10T, 9300-10D, 9382-10D, 3552-10D pH electrode)
	3200382482	Electrode protection cap for long electrode (for 9680S-10D, 9480-10C pH Electrode)

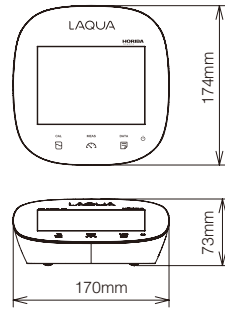

Body • Standard Electrode Stand

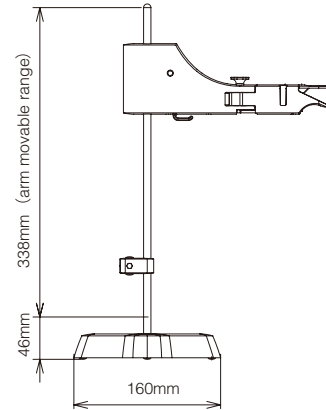

Long Type Electrode Stand

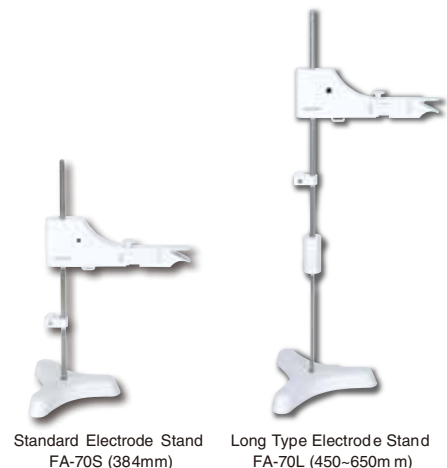
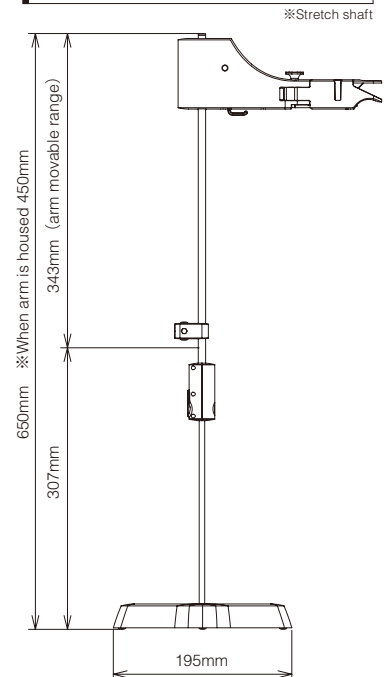

With over 60 years of engineering excellence, HORIBA's diverse range of water quality analyzers and electrodes are ideal for everyday laboratory needs through to the most demanding of applications. Visit our website for a wealth of useful information and water quality measurement tips to help you obtain the best results in your work.



Benchtop Meters

Developed using extensive feedback from users, our new LAQUA meters deliver the best solution for water quality analysis. Our LAQUA website features an online 'Selection Guide' to enable you to find the perfect LAQUA meter and electrode for your need.



Handheld Meters

In the lab, in the field or anywhere you need it. LAQUA Handheld meters are designed for use with one hand and with an IP67 waterproof rating and shock-resistant casing. Meters can be used for long periods, even in dark places, making it ideal for field measurements in rivers and lakes.



Electrodes

Various electrodes to match any application. A wide range of products for both benchtop and portable systems are available, including easy and reliable standard models, application-focused models for small samples or large containers, and special electrodes for specific sample characteristics.



Pocket Meters

Analyzing water quality is simplified when using our LAQUAtwin range of meters. Designed to produce accurate and reliable results. Anyone, anywhere, at any time can measure samples easily with a LAQUAtwin meter. See just how good they are at our website.



Application Notes

LAQUAtwin pocket meters offer quick and convenient alternative to analyze important parameters with high accuracy. Several application notes are available at (<http://goo.gl/znwE6j>) detailing the use of LAQUAtwin and the results achieved for the respective applications. Additional application notes will be added when available.



- The contents of this catalog are subject to change without prior notice, and without any subsequent liability to this company.
- The color of the actual products may differ from the color pictured in this catalog due to printing limitations.
- It is strictly forbidden to copy the content of this catalog in part or in full.
- All brand names, product names and service names in this catalog are trademarks or registered trademarks of their respective companies.
- Windows is a registered trademark of Microsoft Corporation in the United States and other countries.

HORIBA Instruments (Singapore) Pte. Ltd.
 83 Science Park Drive, #02-02A,
 The Curie, Singapore 118258
 Phone: 65 6908-9660
 Fax: 65 6745-8155
 e-mail: laqua@horiba.com
www.horiba-laqua.com

HORIBA UK Limited
 Kyoto Close, Moulton Park,
 Northampton NN3 6FL
 Phone: 44 (0) 1604 542567
 Fax: 44 (0) 1604 542699
 e-mail: waterquality@horiba.com
www.horiba.com/uk

