

## multipulse, multilog

### Installation and operating manual

*Electronic pulse counter module  
with 3 inputs for connection  
of meters with pulse outputs*



## General information

With multipulse resp. multilog you have acquired one of the most up-to-date and modern electronic pulse counter modules currently available on the market.

Expressive symbols in the display and easy menu navigation make readout simple. It can be operated with one single button. The change of pulse values and the setting of the data loggers with multilog is being done via the software GMM.

The pulse counter module is equipped with a long-life battery made for operation during a period of 5 years including a reserve of at least another year. With a second battery you will reach 11 years.

### Electro-magnetic interference





multipulse resp. multilog fulfils the national and international requirements for interference resistance. To avoid malfunctions due to other interferences, do not install fluorescent lamps, switch cabinets or electric devices such as motors or pumps in the immediate vicinity of the meter (minimum distance 1 m). Cables leaving the meter should not be laid parallel to live cables (230V, minimum distance 0.2 m).

### Care instructions

Clean plastic surfaces with a damp cloth only. Do not use any scouring or aggressive cleaning agents! The device is maintenance-free during the service life. Repairs can only be made by the manufacturer. The most up-to-date information about this product can be found at [www.zenner.com](http://www.zenner.com)

## Status display / Error codes

The symbols in the table below show the pulse counting module's operational status. The status messages only appear in the main display! The temporary display of the warning triangle can be caused by special operating states and does not always mean that the device is malfunctioning. However, should the symbol be displayed over a longer period of time you should contact the service company.

Symbol	Status	Event
	Flow existent	-
	Data transmission	-
	Emergency operation	Exchange device
	External power supply	-

Error codes show faults detected by multipulse resp. multilog. If more than one error appears, the sum of the error codes is displayed: Error 1100 = error 1000 and error 100.

Code	Error	Event
100	Emergency operation	Exchange device
1000	Battery life time exceeded	Exchange device
> 8000	Internal hardware error	Exchange device

## Technical data

Display	Multifunctional LCD, 8-digit, floating
Interface meter	Models with contact pulsers or active pulsers (no Namur or Opto) Reed max. 1Hz /active max. 100 Hz
Interfaces	optical, optionally ZR-Bus, M-Bus, RS-232, remote readout outputs
Ambient temperature	°C 0 - 55
Power supply	Battery 3.6 V Lithium, optionally mains supply 230 V
Battery lifetime	6 years, optionally 11 years
Protection class	IP 54 / IP 65, acc. to DIN 40050
Mechanical/electro-magnetic class	M1/E1

## Technical data flow sensor input

### Flow sensor input

#### Electrical connection

#### Schematic diagram

#### Connection data

Passive with mechanical contact (Reed)



**1 Hz Version:**  $f_{max} = 1$  Hz, Pulse-duty factor 1:1 to 1:9 Input capacitance: approx. 10 nF, Input resistance approx 850 kOhm  
**100 Hz Version: not allowed**

Passive with open drain FET

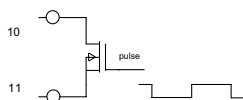

**1 Hz Version:**  $f_{max} = 1$  Hz, Pulse-duty factor 1:1 to 1:9 Input capacitance: approx. 10 nF, Input resistance approx 850 kOhm  
**100 Hz Version:**  $f_{max} = 30$  Hz, Pulse-duty factor 1:1, Input capacitance: approx. 2,5 nF, Input resistance approx. 850 kOhm

Active f.ex. with C-MOS Gate

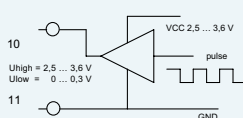

**1 Hz Version:**  $f_{max} = 1$  Hz, Pulse-duty factor 1:1 to 1:9  $U_{high} = 2,5 \dots 3,6$ V,  $U_{low} = 0 \dots 0,3$  V, Input capacitance: approx. 10 nF, Input resistance approx 850 kOhm  
**100 Hz Version:**  $f_{max} = 100$  Hz, Pulse-duty factor 1:1  $U_{high} = 2,5 \dots 3,6$ V,  $U_{low} = 0 \dots 0,3$  V, Input capacitance: approx. 2,5 nF, Input resistance approx. 850 kOhm

### Technical data additional inputs

#### Electrical connection

#### Schematic diagram

#### Connection data

Passive with mechanical contact (Reed)



$f_{max} = 1$  Hz,  
 Pulse-duty factor 1:1 to 1:9  
 Input capacitance: approx. 15 nF,  
 Input resistance approx 470 kOhm

Passive with open drain FET

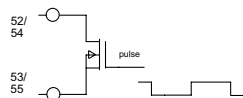

$f_{max} = 1$  Hz,  
 Pulse-duty factor 1:1 to 1:9  
 Input capacitance: approx. 15 nF,  
 Input resistance approx 470 kOhm

### Connection data outputs

Ext. Voltage  
 Max. current

3V ... 30 V DC  
 20 mA

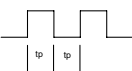

Typical connection

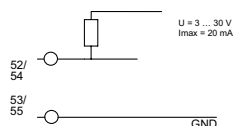

Output frequency

1 Hz (8 Hz dynamically switching, if output with 1 Hz is not possible)

Switching times:

1 Hz:  $400\text{ms} < t_p < 600$  ms  
 8 Hz:  $50\text{ms} < t_p < 80$  ms

$U = 3 \dots 30$  V  
 $I_{max} = 20$  mA

## Dimensions

Height: H = 106 mm

Width: B = 126 mm

Depth: T = 54 mm

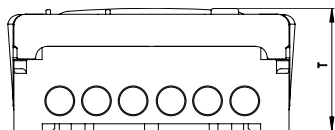
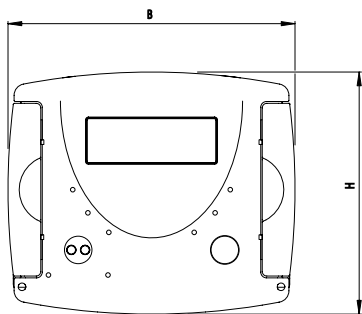

## Communication

The pulse values can be programmed via the software GMM. The pulse value can be called up in the display (see the display overview, Level 1).

The display resolution should be chosen in such way that the display can not overflow within one years time.

### M-Bus (optional)

The optional M-Bus interface complies with the norm EN 1434-3 and operates with 2400 baud fixed. It can be set to 300/9600 baud if necessary.

## ZENNER International GmbH & Co. KG

Römerstadt 4  
D-66121 Saarbrücken

Telephone +49 681 99 676-30  
Telefax +49 681 99 676-3100

E-Mail info@zenner.com  
Internet www.zenner.com

## Installation instructions

### Safety instructions

The installation has to be done by qualified personnel. Read the instructions carefully right up to the end before starting to mount the device.

The current laws and regulations regarding the installation have to be observed

At devices with communication interfaces or mains supply the general technical rules and the correspondent regulations have to be followed.

### General Information

Take care of:

- the display of the module must readable at all times,
- to avoid malfunctions due to other interferences do not install fluorescent lamps, switch cabinets or electric devices such as motors or pumps in the immediate vicinity of the module (minimum distance 1 m),
- the ambient temperature must not exceed 55°C,
- the pulse value of the meter must correspond with the one from the module.

The module has 7 cable glands for wires with a diameter between 4,2 and 10 mm. Keep unused glands closed. multipulse resp. multilog is delivered ready for operation. It does not need any settings or adjusting.

### Installation pulse counting module

ZENNER recommends to mount the module on the wall.

Do not mount the device at the pipe or attach it directly on the meter. The mounting adapter at the backside of the module can be used for rail mounting or for wall mounting.

For wall mounting detach the adapter and turn it 180°, attach the adapter with at least two screws to the wall and clip the module on it.

For rail mounting lift the adapter a little bit, place the module on the rail and push the adapter back until it locks.

### Connection meter

With mechanical meters the connection order is optional. Mind the polarity at electronic meters.

### External power supply

A small vertical line appears in the display when the optional external power supply is on service. In case of a failure of the external power supply the devices switches automatically to battery supply.

The battery lifetime can be checked in the display (level 3). After having reached the date the battery has to be replaced if needed.

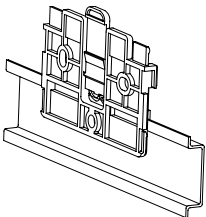

Rail mounting

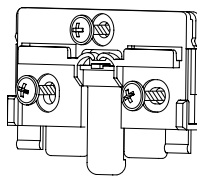

Wall mounting



### Operation test

Check the pulse counter module for any error codes in the display after installation (see table for error codes).

Most of the errors can be deleted by pressing the button. If the error appears permanently, it will be detected at the next measuring cycle and displayed again.

When attaching the top cover on the housing pulses on the inputs can possibly be generated. Check readings of the inputs and correct if necessary.

### Sealing

We recommend sealing the device with the included seals to prevent unauthorized opening.

### Maintenance

Repairs or overhaul are only allowed by the manufacturer or companies authorized by the manufacturer.

## Connector pin assignment

### Main input

Volume pulse	10
Volume GND	11

### Additional inputs

I/O 1 pulse	52
I/O 1 GND	53
I/O 2 pulse	54
I/O 2 GND	55

### M-Bus

M-Bus A	24
M-Bus B	25

### RS-232

DTR	71
GND	72
Tx	73
Rx	74

### RS-485

+UB	71
GND	72
A	73
B	74

### Note

You can download additional information in our product area at [www.zenner.com](http://www.zenner.com).

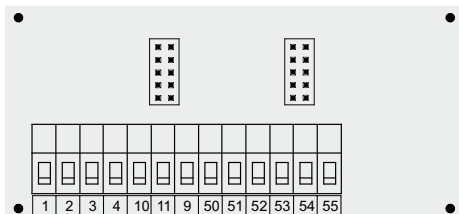

Version without interface

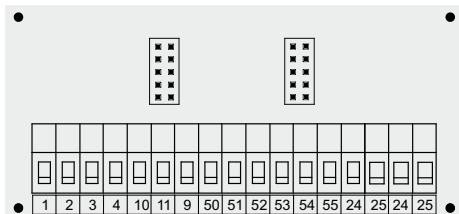

Version M-Bus

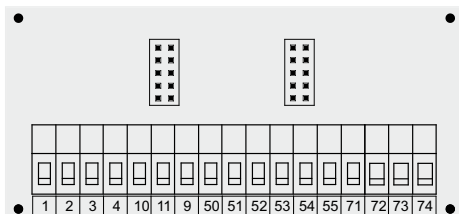

Version RS 232 / RS 485 (ZR-Bus)

If water meters with a potential free reed contact are connected to the inputs the connection can be made in any direction.

The connectors are given twice for the incoming and outgoing of the M-bus wires.

Depending on the pulse counter module's model the version of the connection board can differ.

## Level 1

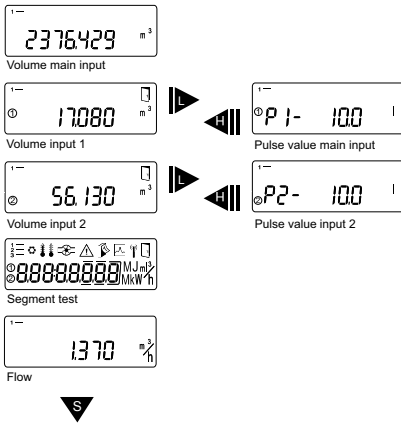

## Level 2

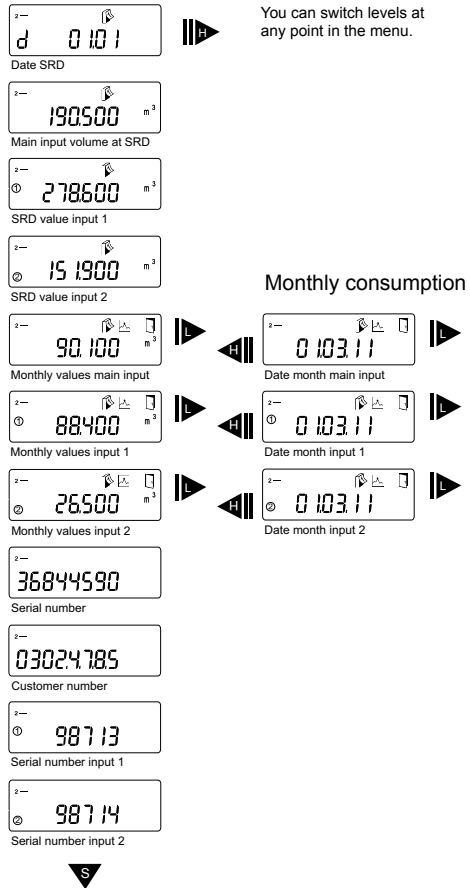

You can switch levels at any point in the menu.

### Level 3

1- 100 ↘

Pulse value main input



3- bRS 05rL

Basic configuration

1- 1300 178

Model number

3- E0b 2020

Date battery end

1- 1436

Time

3- d 170311

Date

1- Adr 001

M-bus address

3- bAU 2400

Baud rate

1- rE 583.14

Remaining energy read-out

1- InP 000

Input display

3- Err 5

Error status

3- [53] 0103

Software version



6- 90.100 m<sup>3</sup>

Monthly value main input

6- 88400 m<sup>3</sup>

Monthly value input 1

6- 13400 m<sup>3</sup>

Monthly value input 2

### Legend



Press the button briefly (S), to switch through the display from top to bottom. When having reached the last menu item the device automatically jumps back to the menu item at the top (loop).



Press the button for about 2 seconds (L), wait for the door symbol to appear (upper right corner of the display) and then release the button.

The menu is then updated resp. switches to the sub-menu.



Hold down the button (H) until the device switches to another level or switches back from the sub-menu.

### Note

Depending on your multipulse or multilog model its displays can differ in number and order from those shown here.